

SL906 EXCEL 850 85CM UNDERMOUNT HOOD

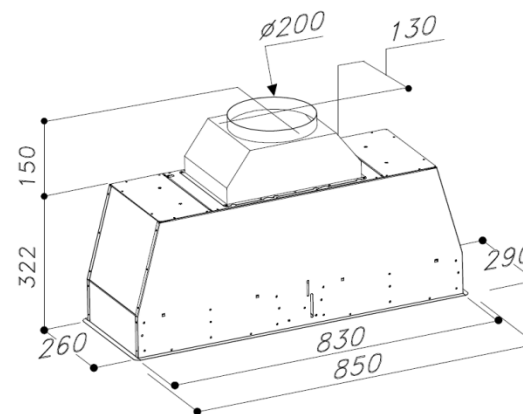





FEATURE	BENEFIT
UNDERMOUNT DESIGN	Streamline, modern and unobtrusive design, potentially allows greater use of cupboard space above hob
HALOGEN LIGHTS	Energy efficient, Better illumination of cooking area, Longer life span than standard globes, Modern aesthetic
25MM COMMERCIAL STAINLESS STEEL BAFFLE FILTERS	Commercial design, Dishwasher safe, Designed for greatest air movement for maximum performance, Easy to fit and remove, Lifetime filters: last the life of the hood
INDUCTION COUNTDOWN CONTROL	10 minute auto function used at the end of cooking to reduce condensation build up common to induction cooking. 'C' shaped baffles eliminates moisture dripping onto cooking surface
LARGER DUCTING DIAMETER	Greater extraction and lower dB rating due to less air flow restriction
CLEAN FILTER INDICATOR	Takes the guessing game out of maintaining your hood
MADE IN ITALY	Units are designed specifically for the Australian market and manufactured in Italy by dedicated boutique specialist manufacturer

MODEL	CONTROL PANEL	MOTOR	EXTRACTION	DUCTING DIAMETER	LIGHTS	FILTER	ELECTRICAL REQUIREMENT	dB RATING	PRODUCT DIMENSIONS
SL906 EXCEL 850	ELECTRONIC CONTROL	TWIN ALUMINIUM EBM	2000m/3h	200mm	2 x 20W HALOGEN	25mm COMMERCIAL STAINLESS STEEL BAFFLE	10A	59dB	850 x 290 x 472





RECOMMENDED DUCTING FOR INSTALLATION





SEMI RIGID DUCTING INSTALLATION – 200mm WALL VENTED

	SRPL30-200 12MM GAUGE SEMI RIGID DUCTING - 3 METER LENGTH
	GDC-200 INTERNAL DUCT CONNECTOR REQUIRES MINIMUM x 1 (TO CONNECT HOOD TO DUCTING) ADDITIONAL REQUIRED 1 x PER EXTRA 3M DUCT
	URC25-325 (PAIR) UNIVERSAL RING CLAMPS USED TO CONNECT DUCTING TO EXTERNAL VENT
	VENTS: SDV-200 RAIN DOME, WALL MOUNTED FOR SQUARE OF EAVE VENST, 150MM VENT PLUS GDR150/200 REQUIRED

SOLID DUCTING INSTALLATION – 200mm WALL VENTED

	GP10-200 GALV STEEL SOLID DUCTING - 1 METER LENGTH GP12-200 GALV STEEL SOLID DUCTING – 1.2 METER LENGTH
	GDC-200 INTERNAL DUCT CONNECTOR REQUIRES MINIMUM x 2 (TO CONNECT DUCTING TO HOOD AND VENT) ADDITIONAL REQUIRED 1 x PER EXTRA DUCTING LENGTH
	easyFIT BEND OPTIONS (SELF CONNECTING, NO INTERNAL DUCT CONNECTOR REQUIRED): GE45-200 45° ELBOW – GALVANISED STEEL GE90-200 90° ELBOW – GALVANISED STEEL
	VENTS: SDV-200 RAIN DOME, WALL MOUNTED FOR SQUARE OF EAVE VENTS, 150MM VENT PLUS GDR150/200 REQUIRED

SOLID DUCTING INSTALLATION – 200mm THROUGH ROOF VENTED

	GP10-200 GALV STEEL SOLID DUCTING - 1 METER LENGTH GP12-200 GALV STEEL SOLID DUCTING – 1.2 METER LENGTH
	GDC-200 INTERNAL DUCT CONNECTOR REQUIRES MINIMUM x 2 (TO CONNECT DUCTING TO HOOD AND ROOF COWL) ADDITIONAL REQUIRED 1 x PER EXTRA DUCTING LENGTH
	easyFIT BEND OPTIONS (SELF CONNECTING, NO INTERNAL DUCT CONNECTOR REQUIRED): GE45-200 45° ELBOW – GALVANISED STEEL GE90-200 90° ELBOW – GALVANISED STEEL
	ROOF FLASHING (SILICONE SOFT FORMING ALUMINIUM – 25 YEAR GUARANTEE): MRF-G178 SUITABLE FOR METAL ROOF TRF-G203 SUITABLE FOR TILED ROOF
	GRC-200 ROOF COWL – GALVANISED STEEL

HINTS AND TIPS ON DUCTING

- The less bends the better the extraction and quieter your hood will be
- Inferior ducting such as PVC, air con ducting and flexible ducting will void your warranty and reduce the efficiency of your hood
- easyFIT connections on Sirius ducting eliminates the need for riveting or taping joints
- For easyKIT options refer website / brochure
- For best results with installation, use only a Sirius preferred installer. Refer website for details

WARRANTY - All Sirius hoods come with a total peace of mind 3 year warranty covering parts and labour.

- Using Sirius branded ducting will increase your warranty to **4 years**
- All off board motors come with a full 10 year warranty
- We highly recommend hood installation by a qualified and preferred installer. A list of these installers can be located on our website.
- Incorrect or inferior installation will result in voiding your warranty.
- Please refer to product installation instructions supplied with the hood
- Go to www.arisitwarranties.com to register your product

CONTACT

Arisit Pty Ltd:

ABN: 23 091 515 294

40-44 Mark Anthony Drive

Dandenong South, VIC 3175

Ph: Sales and Service: 1300 762 219

W: www.siriuisbrand.com